

# **KING-GAGE®**

## **D/P Module 4–20 mA Pressure Transmitter**

### **Operation/Calibration Manual**

**User Guide to Range  
Calculation, Calibration  
Procedures, Zero/Span  
Adjustments for Differential  
Pressure Transmitters**



© 2010 King Engineering Corp. All rights reserved.

The information contained in this manual was accurate at the time of release. Specifications are subject to change without notice.

**WARRANTY**—All King Engineering products are guaranteed to be free from defects in material and workmanship for one year from the date of purchase. Any product or part found to be defective under normal use within one year of purchase will be repaired or replaced at no charge if returned to the company at Ann Arbor, Michigan within ten days of discovery of the defect. No other warranties, whether express, implied or statutory, including the warranties of fitness for a particular purpose or merchantability, are given by this agreement. The exclusive remedy for nonconformity of these goods shall be repair and/or replacement of the nonconforming goods or parts.

Seller will not be liable for consequential damages resulting from breach of this agreement. The term "consequential damages" shall include but shall not be limited to damage to all machines, equipment and goods other than the goods sold hereby, interruption of production, loss of profits, delays of any kind, administrative expense and overhead.

#### **Revisions:**

April, 1987 – original release

December, 1987 – revised test equipment specifications

August, 1990 – revised zero/span adjustment

August, 1991 – corrected zero/span positions (pg. 11)

September, 1994 – revised text (update model numbers)

February, 1998 – LP2 3-terminal signal connector (pg. 15)

September, 2010 – revised voltage/load capacity

## Table of Contents

Specifications.....	4
Span Adjustment Range.....	4
Pressure Connections.....	5
Power Requirement .....	5
Load Capacity at Supplied Voltage .....	5
Calibration—Zero/Span Adjustment .....	6
Low Pressure Input (for differential pressure) .....	8
Calibration Test Setup (Typical) .....	9
Pressure Range Calculation .....	10
Troubleshooting .....	11

### Model No. Designations

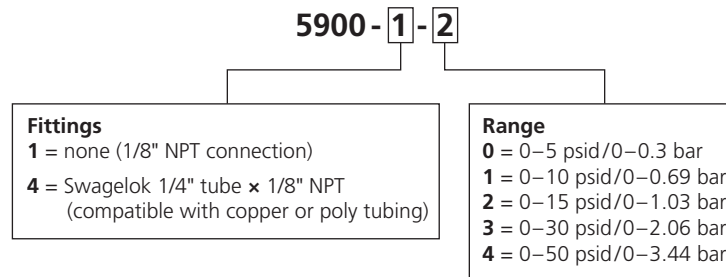

## Application

The D/P Module is a pneumatic-to-current, differential pressure transmitter. It provides a two-wire 4-20 mA output signal suitable for process control or tank level gauging.

## Model 5900 D/P Module

This surface mount transmitter is intended for control room or other protected locations. Modules should typically be mounted within an enclosure or cabinet.

## Specifications

### Pressure Ranges

0–5, 0–10, 0–15, 0–30, 0–50 psid

### Output

4–20 milliamperes (mA<sub>Dc</sub>)

### Accuracy

± 0.20% FS (± 0.10% FS, typical)  
includes non-linearity, hysteresis, non-repeatability

### Repeatability

± 0.02% of calibrated span

### Temperature Range (Environmental)

0°F to 180°F / -18°C to 82°C operating

### Compensated Temperature Range

32°F to 120°F / 0°C to 54°C

### Thermal Effects

(Over Compensated Temp. Range)  
less than .007°F (.011%°C) span shift - sensitivity  
less than .007°F (.011%°C) span shift - zero

### Power Supply Voltage

14–40 V<sub>dC</sub> (unregulated)

### Power Supply Stability

(Effect on FSO) less than 0.005% of span change in output per volt change at input terminals

### Burst Pressure

200 psi

### Span Adjustment Range

Transmitter adjustment turndown is 3:1 for the 0–15, 0–30, 0–50 psid nominal ranges.

Nominal	Minimum	Range of Adjustment
0–5 psid	0–3 psid	0–83 in. thru 0–138 in. water/0–2.1 m thru 0–3.5 m water
0–10 psid	0–3 psid	0–83 in. thru 0–277 in. water/0–2.1 m thru 0–7.0 m water
0–15 psid	0–3 psid	0–83 in. thru 0–415 in. water/0–2.1 m thru 0–10.5 m water
0–30 psid	0–10 psid	0–277 in. thru 0–830 in. water/0–7.0 m thru 0–21.0 m water
0–50 psid	0–15 psid	0–415 in. thru 0–1384 in. water/0–10.5 m thru 0–35.1 m water

### Operating Limit (Maximum Pressure)

Pressure above 300% nominal range (overrange) will result in damage to the transmitter (200% may cause a shift in calibration).

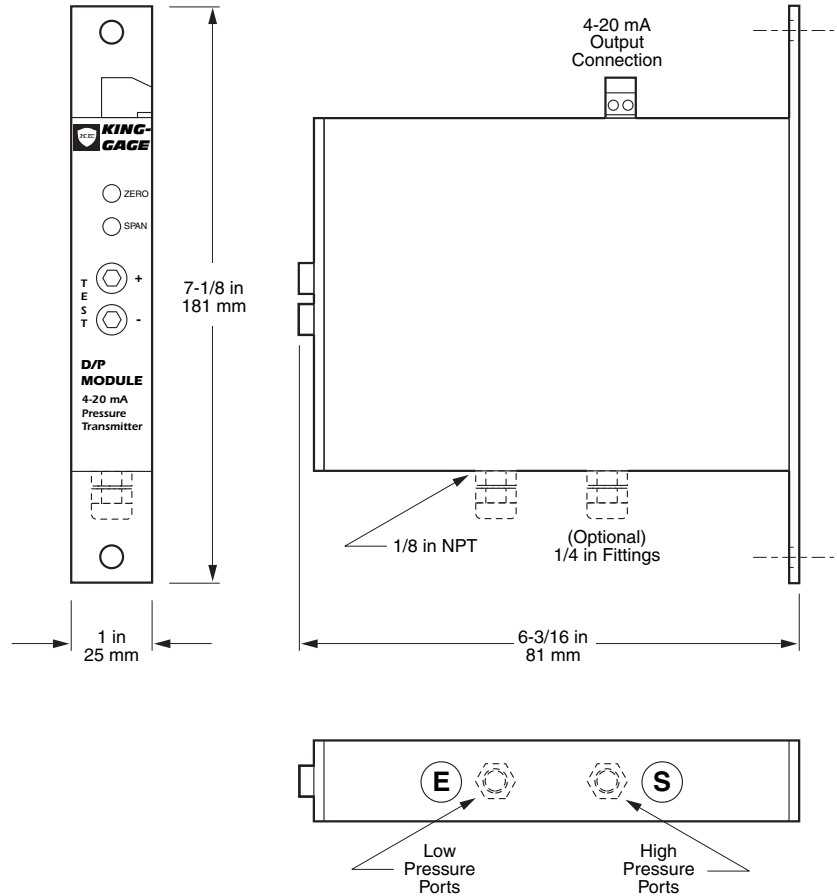

### Pressure Connections

D/P Module Transmitter incorporates two (2) 1/8" NPT ports for HIGH and LOW differential pressure inputs.

- E** vent plug for atmospheric reference (or low pressure input when measuring differential pressure)
- S** connection for pressure input signal (high pressure input when measuring differential pressure)

When application is for psig (gauge pressure), the low pressure port is not used. A vent plug should be installed in the low pressure port to allow transmitter to reference atmosphere. The low pressure port should **never be plugged or sealed!**

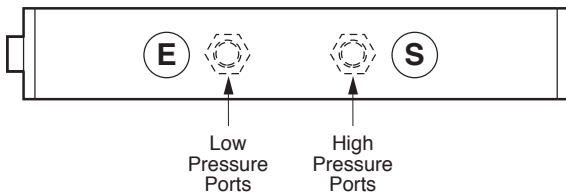

### Signal Loop Connections

A plug-in type terminal connector is furnished for the + Signal and - Signal inputs. Terminal block can be removed to make the cable connections and then re-inserted into the mating socket. Screw clamp terminals are provided for positive (+) and negative or common (-) sides of the signal loop.

As is typical of two-wire transmitters, all electrical power is supplied through the signal loop wiring. Refer to the following diagram for proper wiring of the 4–20 mA loop circuit:

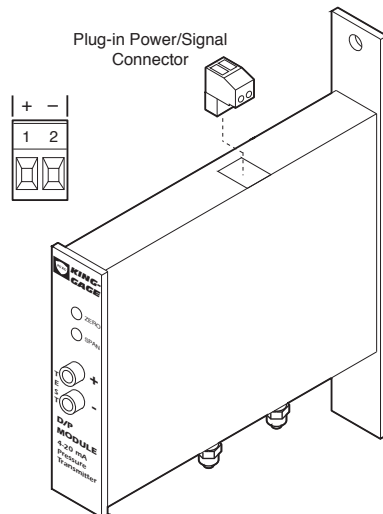

### Power Requirement

The D/P transmitter requires a source of DC power (14–40 Vdc) for operation. Minimum excitation voltage must be no less than 14 Vdc. Any receiver installed on the signal loop (meters, data loggers, controllers, etc.) must be taken into account when determining the required power supply voltage to be used. The internal resistance of each device added together represents the total "load" residing on the signal loop circuit.

$$\frac{\text{Load Capacity}}{\text{(ohms)}} = \frac{\text{(Supply Voltage - 12 Volts)}}{.02}$$

### Load Capacity at Supplied Voltage

20 Vdc	24 Vdc	28 Vdc	32 Vdc	36 Vdc	40 Vdc
400 ohms	600 ohms	800 ohms	1000 ohms	1200 ohms	1400 ohms

KING-GAGE® tank processors and LevelBAR provide 24 Vdc excitation to power the signal loop circuit. (If the application requirement exceeds 700 ohms, an external power supply of appropriate voltage will be required.)

### Signal Cabling

The 4–20 mA signal loop needs to be run using twisted pair (two conductor) cable. "Noise" or EMI (electromagnetic interference) does not generally create a problem since it is common to both wires in the pair and essentially cancels itself out. In most applications, non-shielded twisted pair instrumentation cable (20–22 awg) will be suitable for the signal loop between the LP2 and sensor/transmitter.

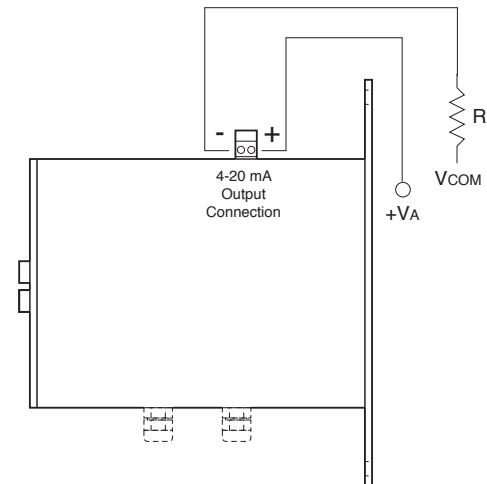

**Test Point Terminals (TP1, TP2)**—Test meter terminals are provided (see diagram) for measuring the output signal without disturbing the signal loop. Do not connect any device or meter whose internal resistance exceeds 20 ohms across these test points. Also refer to “In-Process Zero/Span Adjustment” in the following section.

**D/P Calibration—Zero/Span Adjustment**

This procedure is intended to recalibrate the existing zero and span output settings. It is generally recommended that the zero output be checked at least every 12 months. Generally speaking, slight adjustment of the zero potentiometer is all that is needed to maintain transmitter accuracy. However, since zero is an offset adjustment, shifting this setting upward or downward will have some corresponding effect on span.

**Adjusting Zero Setting**

Check zero by measuring the output using the meter terminal posts (TP1 and TP2) on the transmitter board.

1. Adjust zero potentiometer as necessary to increase output (clockwise) or decrease output (counterclockwise) until the signal displays as 4.00 or 4.01 mA on the test meter.

**Adjusting Span Setting**

This requires applying pressure to the “S” port of the D/P transmitter equivalent to the maximum depth (hydrostatic) pressure. Measure the output using the meter terminal posts on the transmitter board.

2. Adjust span potentiometer as necessary to increase output (clockwise) or decrease output (counterclockwise) until the signal displays as 20.00 or 20.01 mA on the test meter.

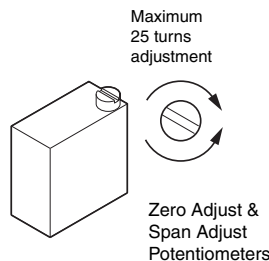

3. Next step is to re-check the zero output and slightly adjust if necessary.

**In-Process Zero/Span Adjustment**

It is possible to make adjustments to the zero setting while the D/P transmitter is installed at the tank. The meter terminal posts permit in-process monitoring without disturbing the loop wiring. Confirm that the tank is empty (or liquid level is below sensor). Measure the transmitter output using a milliammeter (multimeter) and adjust zero potentiometer as required.

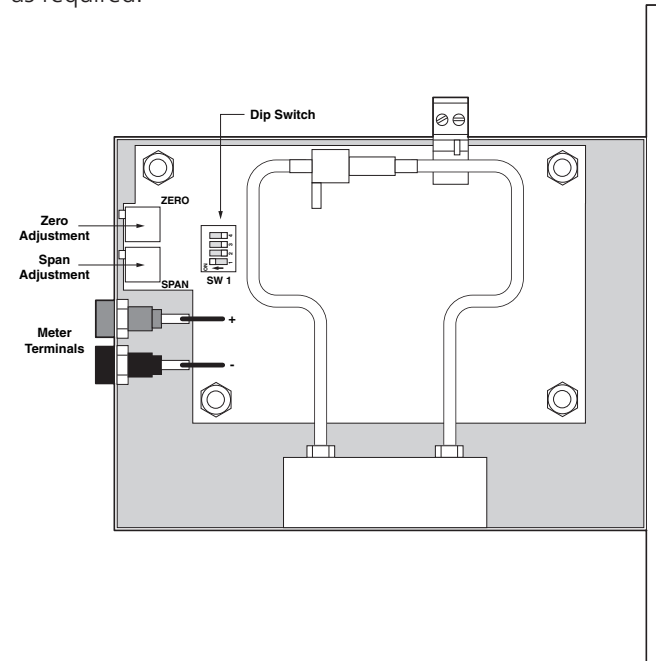

**Using Multimeter:** Set multimeter for DC current, using mA or .001 amp scale. The internal resistance of the meter must be 20 ohms or less since higher resistance values will create incorrect readings. Connect the meter leads to the **TP1** and **TP2** posts on the internal circuit board.

Adjusting span settings of an installed transmitter is not a very precise method for calibration (since the hydrostatic pressure may not be accurately determined). In-process span adjustment is not recommended for this reason.

**D/P Range Adjustment DIP Switch Settings**

The D/P transmitter span can be adjusted from 70% to 140% of the nominal range indicated by the model number. (Refer to Model No. Designation on page 3.) This is how the transmitter’s pressure range can be changed for a specific application. When the D/P transmitter is used with a KING-GAGE® digital tank level indicator, the “Application Datapack” (iButton memory module) is generally programmed with the nominal range setting. The indicator programming will correlate the output signal to tank capacity regardless of whether the maximum tank level generates less than 20 mA output from the transmitter.

**WHEN NOT TO CHANGE SPAN**—If a KING-GAGE indicator is part of the system, you should not have to change the range (span) of the transmitter.

**Coarse Range Setting**

An initial coarse range setting is provided by the DIP switches. Use the previously outlined Zero/Span Calibration to achieve the final trim setting for precise 4–20 mA output over the intended pressure range.

The DIP switches on the transmitter circuit board affect the span (range) of the transmitter. These provide coarse adjustment in addition to the fine span adjustment of the potentiometer. Please refer to the individual DIP switch positions listed for adjusting the existing setting of the transmitter.

The four (4) switches provide 16 increments of coarse adjustment. Prior to changing any switch setting, check the current output of the transmitter at the desired upper pressure value. Also note the existing switch setting.

1. Apply the desired maximum pressure to the sensing diaphragm of the D/P transmitter (requires a pressure test shell available from King Engineering).
2. Record the existing setting positions of the DIP switches.
3. Adjust the potentiometer to maximum output by turning clockwise until it “clicks”.
4. To increase the milliamp output, use a higher switch setting arrangement; to reduce the milliamp output, use a lower switch setting arrangement. (The goal is to achieve a output signal value just slightly above 20 milliamps and then use the potentiometer to trim the setting.)
5. Follow the Zero/Span Calibration procedure to check both the zero and span output.

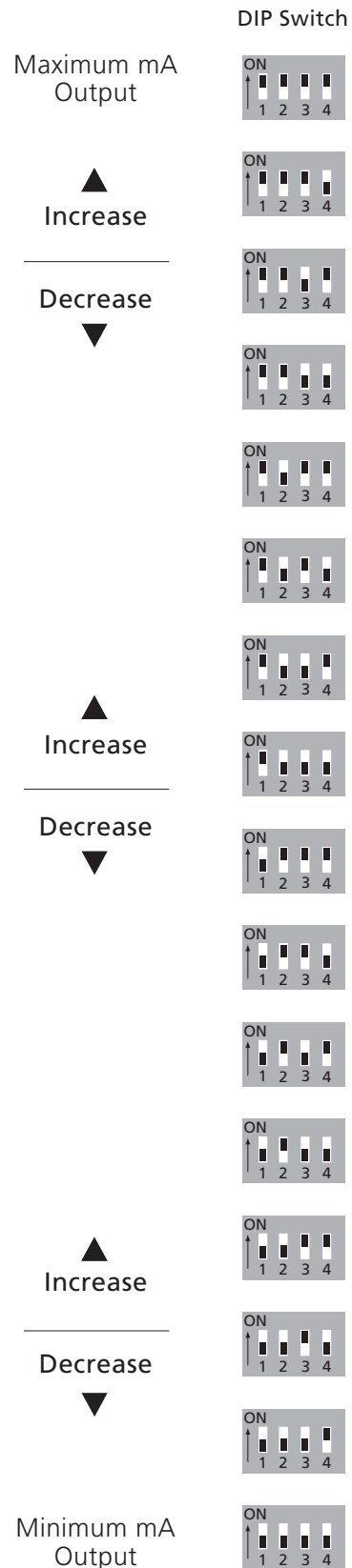

**Coarse Range Setting—Alternate Version**

Previous versions of the D/P transmitter employ similar DIP switches, but only offer 5 increments of coarse adjustment. With these versions, the span potentiometer offers greater range of adjustment.

**Coarse Setting Procedure:** The number of switches in the ON position will increase the milliamp value as each switch controls an identical fixed resistor. To increase milliamp output, place additional switches into the ON position. To decrease milliamp output, move switches to the off position.

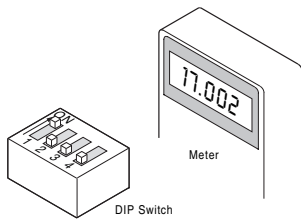

**DIP Switch—Coarse Adjustment**

**Range Less Than 3.00 PSID**

When the nominal 5 psid transmitter is used on an application whose maximum pressure is less than 3.00 psid, the full calculated range output will be less than 20 mA. To determine the actual milliamp output of the transmitter when the maximum applied pressure is below the lower span limit, use the following formula:

$$\frac{(16 \times \text{Calculated PSID})}{3.0} + 4 = \text{mA Output}$$

**Note**

The above formula may also be used for other nominal range transmitters if maximum applied pressure will be less than the adjustment range allows. Merely divide by the lower span limit psid value (listed above) in place of the “3.0” shown in the formula.

**Low Pressure Input**

**Internal Tank Pressure or Vacuum**

In a closed, pressurized or evacuated tank, it is necessary to measure differential pressure. This is achieved by subtracting the internal pressure condition of the tank above the surface of the liquid from the total pressure sensed at the bottom of the tank. When the low pressure is applied to one side of the transmitter sensing element and the high pressure to the other side, the internal tank pressure above the liquid (low pressure) is balanced across the sensing element. This is also referred to as being “equalized” (which is why we designate the low pressure connection as “E”).

CAUTION: While the internal pressure above the liquid is not a factor in determining range (span), there may be instances where the sum of the liquid and internal pressure exceeds the 150 psi burst pressure rating of the transmitter. Also, do not subtract pressure when a vacuum condition is present within the tank (since loss of vacuum would be seen as an increase at the high pressure connection of the transmitter).

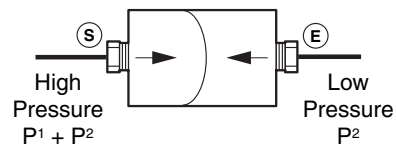
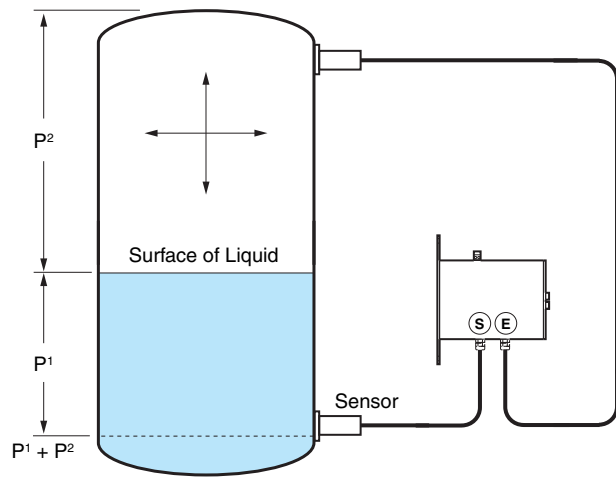

$$(P1 + P2) - P2 = P1$$



### Calibration Test Setup (Typical)

This D/P transmitter has a specified accuracy of  $\pm 0.15\%$ . To ensure your calibration maintains this degree of accuracy, the equipment used to check zero and span settings must conform to the recommendation listed below. Use of equipment with less than specified accuracy figures will not provide acceptable results. King assumes no responsibility for transmitter accuracy if test equipment does not meet recommended minimum standards.

**Recommended Equipment:**

**MILLIAMMETER;** 3-1/2 digit minimum, 0.05% accuracy (20 ohms max. internal resistance)

**DC POWER SUPPLY**

**PRESSURE INDICATOR; PSI or IN. OF WATER**

0.05% accuracy corresponding to transmitter range

5 psid nominal	$\pm .0025$ psi or $.0693$ " of water
10 psid nominal	$\pm .005$ psi or $.1385$ " of water
15 psid nominal	$\pm .0075$ psi or $.2078$ " of water
30 psid nominal	$\pm .015$ psi or $.4156$ " of water
50 psid nominal	$\pm .025$ psi or $.6927$ " of water

**NOTE**—The low pressure port ("E") of transmitter must be vented to atmosphere during the calibration and adjustment procedures.

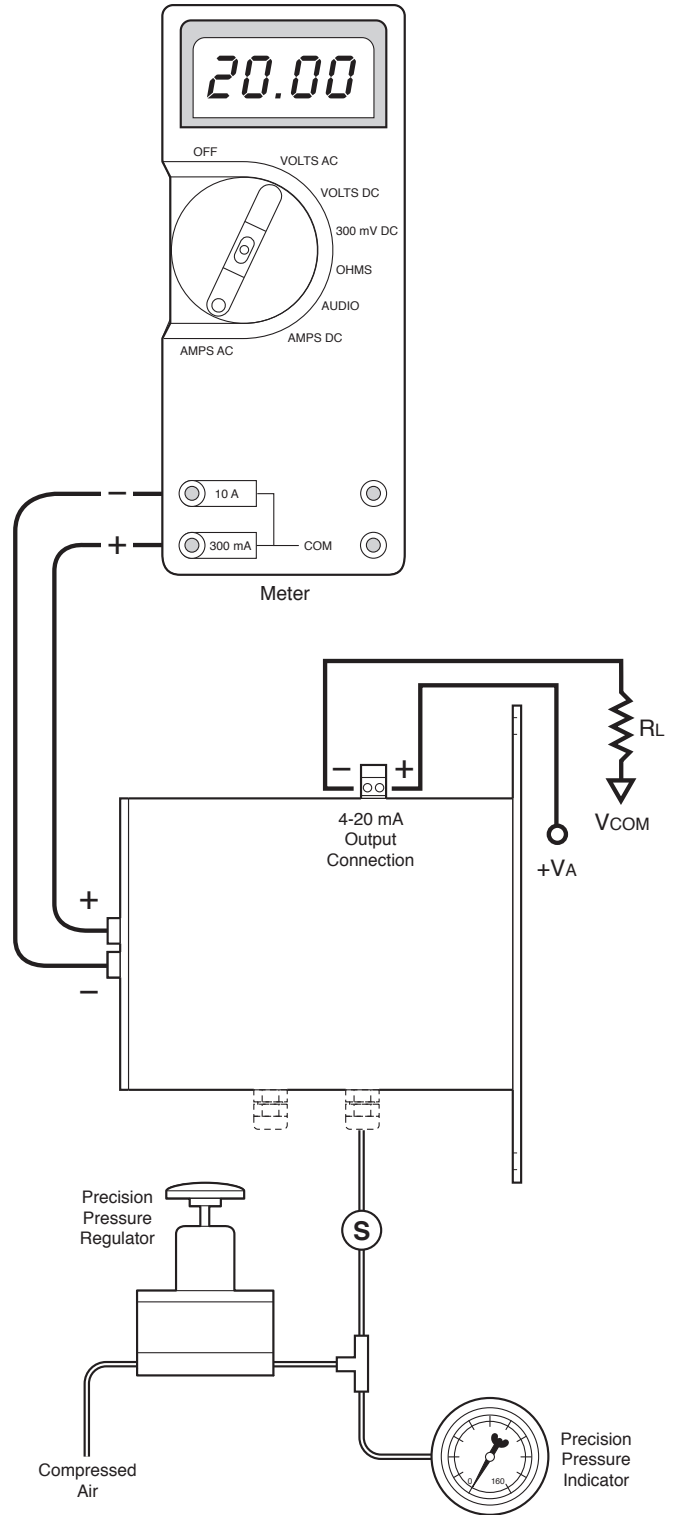

### Pressure Range Calculation

There are two simple equations that can be used to determine the actual range (span) required for the transmitter. One of these gives the range in psid and the other in INCHES OF WATER.

$$\frac{(B - A) \times C}{27.6807} = \text{Range (psid)}$$

**Where ...**

- A = Reserve (inches of depth from low point of tank to sensor)
- B = Full Tank (inches of depth from low point of tank to full)
- C = Specific Gravity of Tank Contents

### Converting LBS/GAL to Specific Gravity

If the density of the liquid is expressed as pounds per gallon (e.g., 8.6 lbs/gal), the specific gravity can be determined by dividing the value by 8.33 (weight of water per gallon).

### Examples—Pressure Range Calculations

A typical tank gauging application is illustrated in Figure 1. The “reserve” represents the distance from the lowest point on the bottom of the tank to the installed sensor. “Full” is the level of contents at which the tank is filled to capacity (or may be some point below the tank top, as desired). The liquid contents in the tank is water @ 1.00 specific gravity.

- C = 1.00 (Specific Gravity)
- B = 382" (Full Tank)
- A = 30" (Reserve)

$$\frac{(382 - 30) \times 1.00}{27.6807} = 12.72 \text{ psid}$$

$$(382 - 30) \times 1.00 = 352" \text{ water}$$

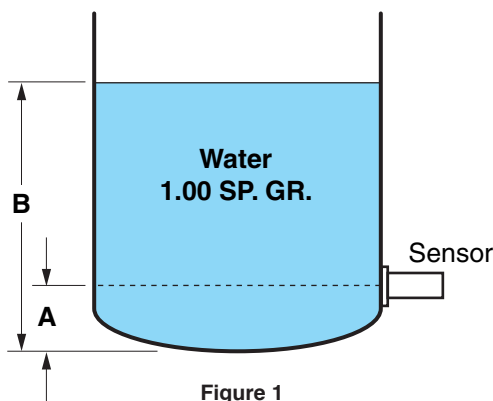

A second tank gauging application is illustrated in Figure 2. The “reserve” represents the distance from the lowest point on the bottom of the tank to the installed sensor. “Full” is the level of contents at which the tank is filled to desired level (which is less than the actual full capacity of the tank). The liquid contents in the tank has a specific gravity of 1.032.

- C = 1.032 (Specific Gravity)
- B = 300" (Upper Level)
- A = 28" (Reserve)

$$\frac{(300 - 28) \times 1.032}{27.6807} = 10.14 \text{ psid}$$

$$(300 - 28) \times 1.032 = 281" \text{ water}$$

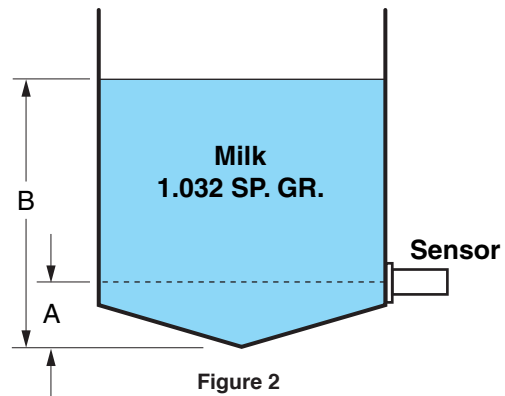

**NOTE**—Should the calculated range exceed the upper span limits of the transmitter, the next higher range is required. If the calculated range falls below the lower span limits, a lower range transmitter is required (to obtain 20 mAdc).

When Output will be Less Than 20 mA ...

### Maximum Pressure Below 3.00 PSID

When the nominal 5 psid transmitter is used on an application whose maximum pressure is less than 3.00 psid, the full calculated range output will be less than 20 mA. To determine the actual milliamp output of the transmitter when the maximum applied pressure is below the lower span limit, use the following formula:

$$\frac{(16 \times \text{Calculated PSID})}{3.0} + 4 = \text{mA Output}$$

### Other Ranges

The above formula may also be used for other nominal range transmitters if maximum applied pressure will be less than the adjustment range allows. Merely divide by the lower span limit PSID value (see page 4) in place of the “3.0” shown in the formula.

## Troubleshooting

### No signal

- Check that Vdc power is connected to the signal loop circuit (V+ at transmitter + signal terminal).
- Polarity reversed- check by reversing the + and - leads at the input terminals.

### Output greater than 20.0 mA

- Check zero output of transmitter—adjust zero to 4.00 mA if necessary.
- Check span setting—adjust to 20.00 mA at nominal range or calculated full pressure.

### Maximum output less than 20.00 mA

- Check that applied pressure is within span limits for transmitter range. (Transmitter has  $\pm 40\%$  span adjustment.)
- Check span setting—adjust to 20.00 mA at nominal range or calculated full pressure.
- Higher resistive load on signal loop may exceed voltage/load capacity (see page 5).

